



Diesel Generators



Output Ratings

Generator Set Model	RE-20
Fuel - HSD	Prime
380 - 415V, 50Hz	15 kVA / 12 Kw

Ratings at 0.8 power factor

Definitions

Standby Rating

The Standby Power rating is only applicable for emergency and standby applications where the generator set serves as the back up to the normal utility source. In installations served by unreliable utility sources (where outages last longer or occur more frequently), where operation is likely to exceed 200 hours per year, the prime power rating should be applied. The Standby Power rating is only applicable for emergency and standby applications where the generator set serves as the back up to the normal utility source. (as defined in ISO 8528-3)

Prime Rating

These ratings are applicable for supplying continuous electrical power (at variable load) in lieu of commercially purchased power. There is no limitation to the annual hours of operation and this model can supply 10% overload power for 1 hour in 12 hours.

Standard Reference Conditions

Ratings in accordance with ISO 8528. All engine performance data based on the above mentioned maximum continuous ratings at Standard Reference Conditions 27°C Air Inlet Temp, 100 Mtrs. A.S.L. 30% relative humidity. Fuel Consumption data at full load with diesel fuel having specific gravity of 0.85 & conforming to BS2869: 1998, Class A2

Engine Technical Data

No. of Cylinders/Alignment:	3 in Line
Cycle:	4 Stroke
Bore/Stroke: mm (in)	95 (3.7) / 110 (4.3)
Induction:	Natural
Cooling Method:	Coolant
Governing Type:	Mechanical
Frequency Regulation, no Load to full load	A1
Frequency Regulation, Steady State	ISO 8528 G1
Compression Ratio:	17.5:1
Displacement: l (cu.in):	1.56
Gross Engine Power kW (BHP)	30 (22)
Air Cleaner Type	Dry Type
Engine Electrical System:	
-Voltage/Ground	12/Negative
-Battery Charger Amps	35/40
Piston Speed, m/sec (ft./sec.)	5.0 (16.4)
Weight (includes lube oil): kg (lb)	390 (859.8)

Ratings and Performance Data

Engine Make & Model	Escorts G-20II
Alternator Manufacturer	Stamford
Generator Control Unit	Woodward
Base Frame	Heavy Duty Fabricated Steel
Canopy/ Acoustic Enclosure	Rishabh
Circuit Breaker Type/Rating	3 Pole MCB
Frequency	50 Hz
Engine RPM	1500

Available Options

Escorts offers a range of optional features to tailor our generating sets to meet your power needs. Options include:

- 1- Upgrade to trailer Mounted Dgset for our rental & Emergency Power supply to Customers
- 2- A wide range of Sound Attenuated Containers
- 3- A variety of generating set control and synchronising panels
- 4- Additional alarms and shutdowns
- 5- A selection of exhaust silencer noise levels

For further information on all of the standard and optional features

for this product please contact your local Dealer or write to us at marketing@rishabhengineering.com

Dimensions and Weights of Engine

Length (L)	Width (W)	Height (H)	Dry	Wet
mm (in)	mm (in)	mm (in)	kg	kg
993 (39)	696 (27.4)	947 (37.2)	370	390

Dry = With Lube Oil

Wet = With Lube Oil and Coolant

Sound Level

Open Type Genset	102 db at 1 Mtr. In open area	Silent Type Genset with Acoustic Enclosure.	<75 db at 1 Mtr. In open area
------------------	-------------------------------	---	-------------------------------

Ratings in accordance with ISO 8528, ISO 3046, IEC 60034, BS5000 and NEMA MG-1/22. Dgset picture may include optional accessories.

Air Systems

Air Filter Type:	Replaceable Element
Radiator-cooled cooling air, m ³ / min	185
Combustion Air kg/hr	239
Heat rejected to ambient air :	
Engine, kW (Btu/mi n.)	3.6 (204.91)
Restriction: kPa (in H ₂ O)	1.5 (6)
Generator, kW (Btu/mi n.)	4.24 (242)
Air density, kg/m ³ (lbf/ft ³)	1.2 (0.075)

Performance

Engine Speed: rpm	1500
Net Power at Rated : hp	
– Prime:	36.2

Alternator Physical Data

Manufactured for TATA by:	Stamford
Model:	S0L2-M1
No. of Bearings:	Single Sealed
Insulation Class:	H
Winding Pitch Code:	2/3 (M)
Wires:	4
Ingress Protection Rating:	IP23
Excitation System:	SHUNT
AVR Model:	NA

Alternator Operating Data

Voltage Rating, V	415
Voltage Regulation (steady state):	+/- 1%
Wave Form NEMA = TIF:	50
Wave Form IEC = THF:	2%
Total Harmonic Content LL/LN:	<6.0%
Radio Interference:	Suppression is in line with European Standard EN61000-6
Radiant Heat: kW (Btu/min)	50 Hz 3.8 (216)

General Information

Documentation
A full set of operation and maintenance manuals and circuit wiring diagrams.

Generating Set Standards
The equipment meets the following standards: BS5000, ISO 8528, ISO 3046,

IEC 60034, NEMA MG-1.22. Rishabh is a fully accredited ISO 9001:2008 company.

Warranty
All equipment carries full manufacturer's warranty. Extended warranty terms available.



Cooling System

Ambient temperature, °C (°F)	45 (113)
Engine jacket water capacity, L (gal.)	3 (0.79)
Radiator system capacity, including engine, L (gal.)	18.5 (4.89)
Engine jacket water flow,Lpm(gpm.) – Standby:	100(26.4)
Heat rejected to cooling water at rated kW, dry exhaust, kW	32.6
Water pump type – Standby:	Impeller
Fan diameter, including blades, mm (in.)	515 (20.27)
Max. restriction of cooling air, intake and discharge side of radiator, k Pa	0.125

Lubrication System

Oil Filter Type:	Spin-On
Total Oil Capacity: Ltrs.	10
Oil Pan: Ltrs.	5
Oil Type:	CH4 15W-40
Oil Cooling Method:	Coolant

Exhaust System

Max. Allowable Back Pressure: kPa (in Hg)	2 (0.6)
Exhaust Manifold type	Dry
Exhaust flow at rated kW, kg/hr	260.4
Exhaust temperature at rated kW, dry exhaust, °C (°F)	700 (1292)
Exhaust outlet size at engine hookup, mm (in.)	75 (2.95)

Fuel System

Fuel supply line, min. ID, mm (in.)	15 (0.59)
Fuel return line, mm. ID, mm (in.)	10 (0.39)
Max. lift engine-driven fuel pump, m (ft.)	1 (3.28)
Fuel prime pum p	Manual
Fuel Filter: quantity, type	1, Spin-on
Recommended fuel	HSD-ASTM D2
Fuel tank capacity , L	170

Fuel Consumption @ 0.85 kg/m³ Density

Diesel, Lph (gph) at % load	Prime Rating
100%	5.9
75%	4.1
50%	3.5

Controller

LCD Display | Run Time Hours, Current, Voltage, Engine RPM, Frequency, Engine Temperature & Oil Pressure, Battery V, Service Due Hours, Language Option Hindi or English.

LCD Fault Displays | High Water Temperature, Low Lube Oil Pressure, Overspeed, Over & Under Voltage, Over & Under Frequency, E-Stop, Low Fuel Level, Over Load,Charging Alternator/ V-Belt Fault, Auxiliary Fault

Standard Features & Accessories

- Master Switch : Start/Off-Reset/Auto
- Remote two wire Start/Stop facility
- Superior Electronics

Language Option: Hindi & English

Dimensions & Weights

Overall Size, L x W x H, mm(in.) 2500(98.4) x 1030(40.5) x 1390(54.7)
 Weight
 Total Genset Weight, Dry, kg (lb.) 1150 (2535)

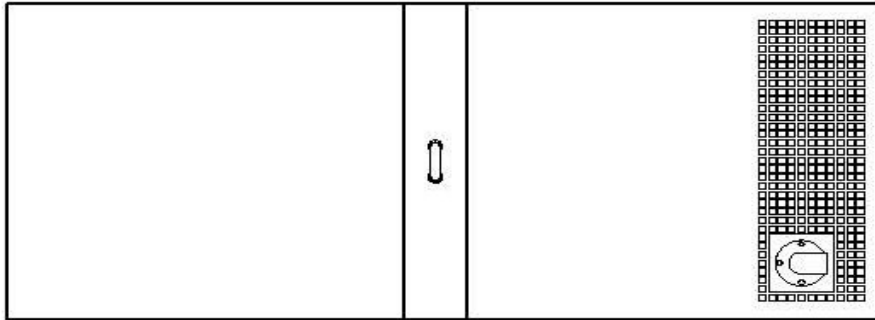

TOP VIEW

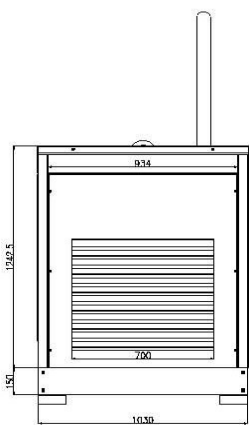

REAR VIEW

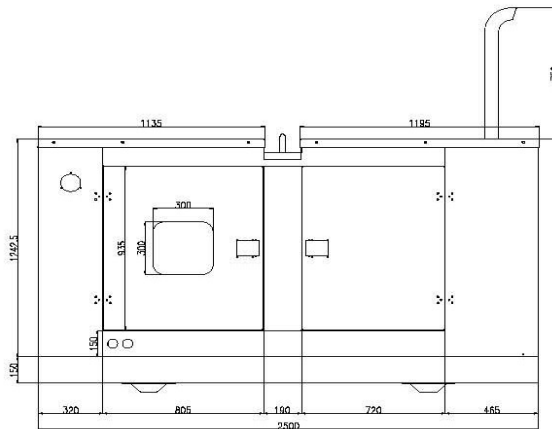

RHS VIEW

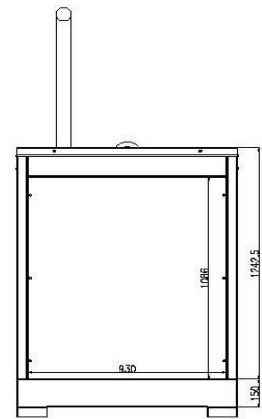

FRONT VIEW

Dgset Mfr By:- Authorized GOEM | TATA Motors



Rishabh Engineering Co.
 217 Richpalpuri, GT Road, Ghaziabad-201001, UP India-201001
 Visit us at www.rishabhengineering.com
www.linkedin.com/company/rishabh-engineering-co
www.facebook.com/RishabhEngineeringCompany/
www.twitter.com/CompanyRishabh

